

# SIAT

MAILLIS

## XL35

### Heavy Duty Carton Sealing Machines

Reliable sealing process thanks to our taping heads



Sturdy "A frame" structure for heavy duty applications

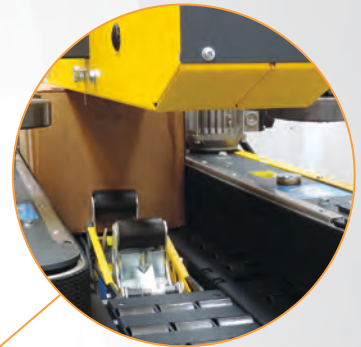

Perfect box control with 75mm height side belts

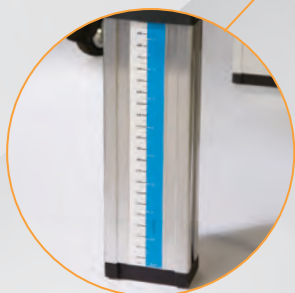

Easy infeed thanks to benchwork rollers

Reinforced welded steel frame 2mm thickness

Aluminium telescopic legs

CE

for more details:



The semi-automatic case sealing **XL35** represents the heavy duty solution in case of uniform size sealing needs. Easy to use and to adjust, it allows the perfect sealing of top and bottom boxes with pressure sensitive tape. Thanks to the self-centering screw adjustment device and the 75mm height belts, the perfect box management is always guaranteed.

**XL35** model has been designed in compliance with CE regulations.



other languages: [www.siat.com](http://www.siat.com)

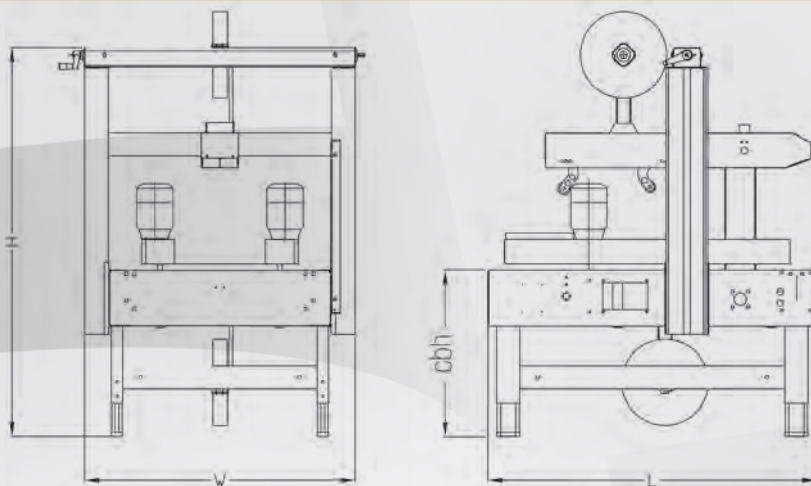

> **Machine dimensions**  
Dimensioni macchina  
Machinemessungen  
Dimensions machine  
Dimensiones de máquina

Size / Weight packaging			LxWxH 
> <b>XL35</b>	185	220	120x106x116

> **XL35**

	Min.	Max
L	938	-
W	1140	-
H	1250	1590
cbh	480	820
AS 77	580	920
AS 80	680	1020

> **Taping units**  
Unità nastranti  
Verschliesseinheiten  
Unitée enrubanneuses  
Unidades de precinto

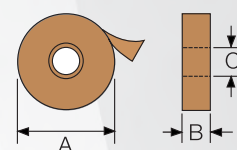

> **Box dimensions**  
Dimensioni delle scatole  
Kartonabmessungen  
Dimensions des boîtes  
Dimensiones de cajas

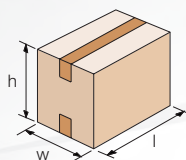

> **XL35**

	K11 / K12	
	Min.	Max
l	150	∞
w	130 / 140	500
h	100	500

> **XL35/4**

	K11	
	Min.	Max
l	150	∞
w	105	500
h	100	500

	K11 / K12	
	mm	
A	410 Max	
B	50 / 75	
C	76	

> **Production capacity**  
Capacità di produzione  
Produktionskapazität  
Capacité de production  
Capacidad de producción

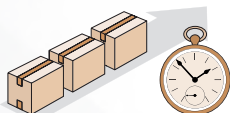

> <b>XL35 - XL35/4</b>	Bph
Max pcs.*	1200

\* Depending on operator dexterity

> **Standard voltage**  
Voltaggio standard  
Standardspannung  
Tension standard  
Voltaje estándar

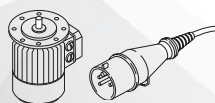

> **XL35 - XL35/4**

<b>380/415V - 50Hz</b>	
<i>Other voltages available on demand</i>	
Amps	1,08
Power kW	0,26
Phase	3Ph + PE

> **Optionals**  
**Accessori**  
**Zübehor**  
**Accessories**  
**Accesorios**

> **AS80**  
Higher legs  
Set gambe più alte  
Höhere Stützen  
Pieds plus hauts  
Patatas más altas



> **AS77**  
Casters  
Set ruote  
Rädchen  
Roulettes  
Ruedas

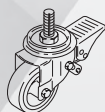

> **RG**  
Roller conveyor  
Piani a rulli  
Rollenbahnen  
Plans à rouleaux  
Rodillos libres



> **GTL - GTR**  
Extendable conveyor  
Rulliera estensibile  
Ausziehbare rollenbahnen  
Convoyeur extensible  
Rodillos extensibles

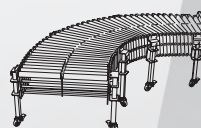

> **K-125 / K-250**  
Inkjet printer  
Stampante ad inchiostro  
Tintenstrahldrucker  
Marqueur à jet d'encre  
Impresora de inyección de tinta

